

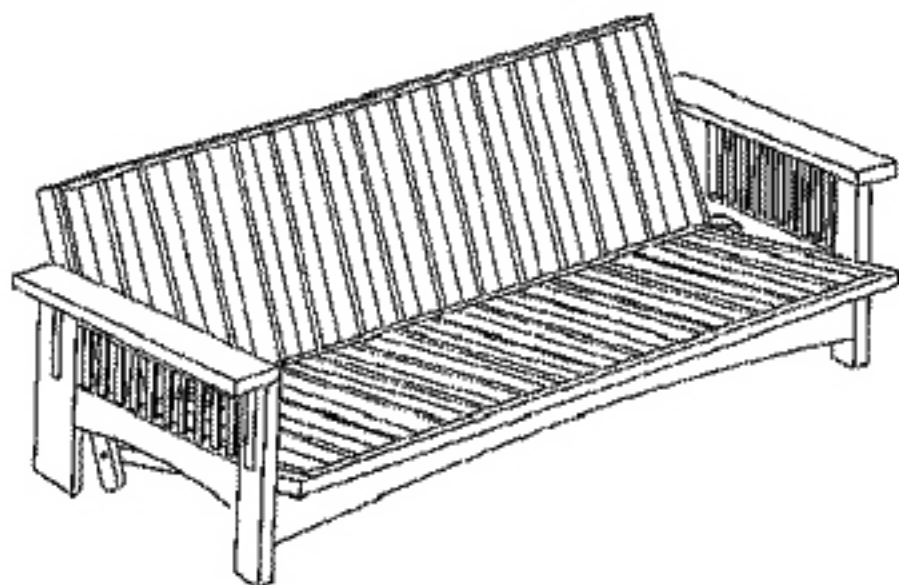









Adonis Furniture: Solid Oak Futon Frame

Assembly Instructions

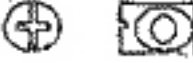

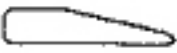
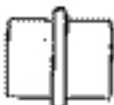
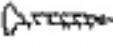
• Adonis Furniture

		WOODEN DOWEL(2PCS) FOR CONNECTING FRONT STRETCHER TO ARMS	(E)
			
LONG BOLTS (8PCS) FOR CONNECTING ARMS TO STRETCHERS	(A)	50MM BOLTS (2PCS) FOR CONNECTING BACK DECK TO SEAT DECK	(F)
			
BARREL NUT (8PCS) FOR CONNECTING ARMS TO STRETCHERS	(B)	ALLEN KEY (1PCS)	(G)
			
PLASTIC STOPPER (4PCS)	(C)	PLASTIC RUNNER (4PCS)	(H)
			
SCREW (8PCS) FOR FIXING STOPPER TO SEAT DECK	(D)	40MM BOLTS (4PCS) FOR FIXING RUNNERS TO BACK DECK	(I)
			

BACK DECK(1PC)

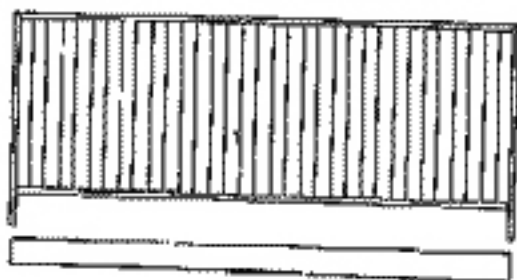

SEAT DECK (1PC)

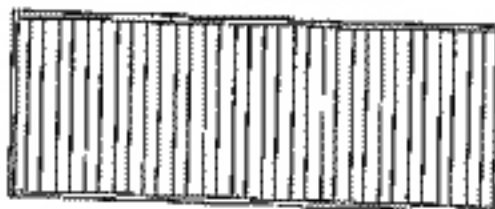

REAR STRETCHER (1 PC)

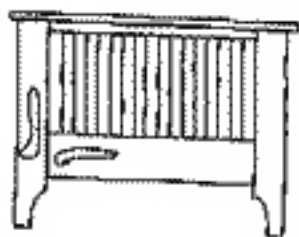

FRONT STRETCHER (1 PC)

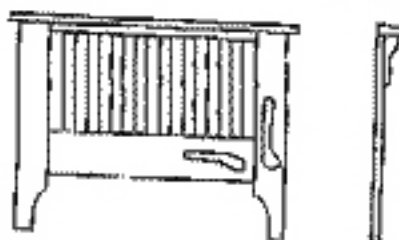

LEFT ARM (SITTING)

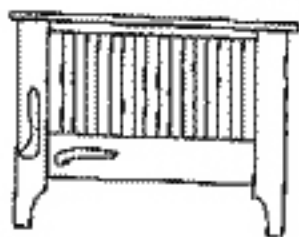

RIGHT ARM (SITTING)

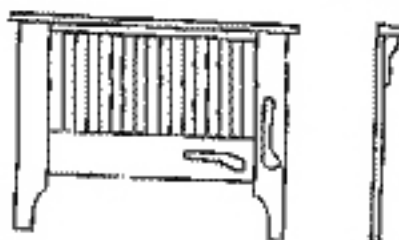

SHAKER

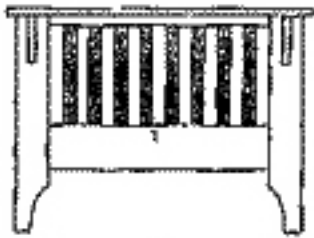

FRONT LEGS(50mm,4Pcs)



BACK LEGS(50mm,4Pcs)



MISSION



FRONT LEGS(69mm,4Pcs)



BACK LEGS(50mm,4Pcs)



FALLINGWATER

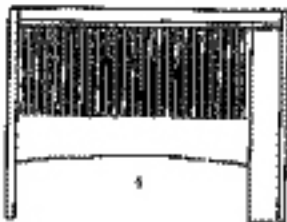

FRONT LEGS(50mm,4Pcs)



BACK LEGS(50mm,4Pcs)



CRAFTSMAN

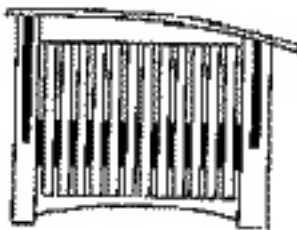

FRONT LEGS(100mm,4Pcs)



BACK LEGS(76mm,4Pcs)



OAK PARK



FRONT LEGS(100mm,4Pcs)

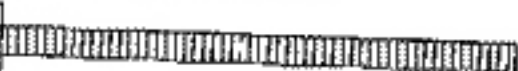

BACK LEGS(100mm,4Pcs)

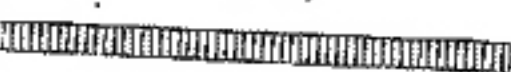

• Adonis Furniture

(1) ATTACH PLASTIC RUNNER TO BACK DECK SIDE RAIL, A METAL INSERT IS EMBEDDED INSIDE THE RUNNER TO ONE SIDE. THE SIDE WITH THE METAL INSERT SHOULD BE FITTED INTO THE FRAME.

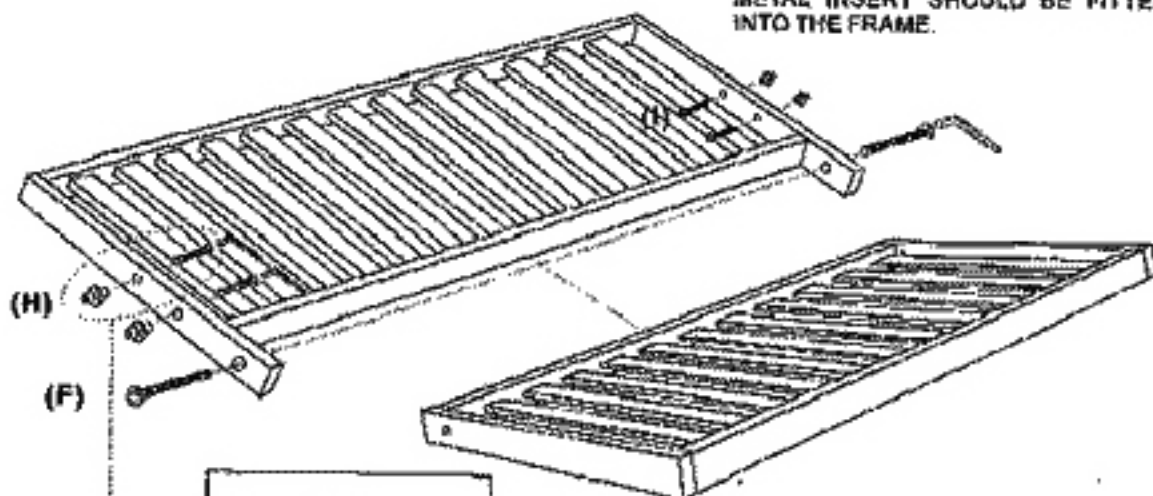

(2) ATTACH THE BACK DECK TO THE SEAT DECK USING 2 PCS OF 60MM BOLTS.

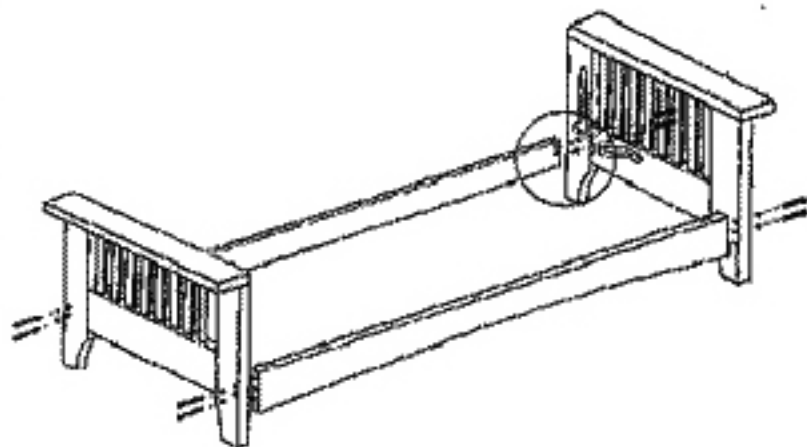

(3) LOOSELY ATTACH STRETCHER RAILS TO THE ARMS USING THE LONG BOLTS AND THE BARREL NUTS. BE SURE TO INSERT WOODEN DOWELS INTO THE FRONT STRETCHER.

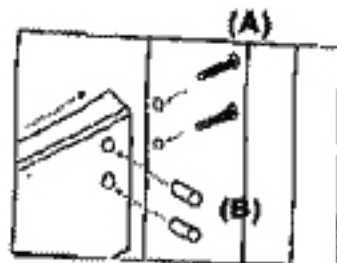

• Adonis Furniture

- (4) FIT DECK INTO POSITION. PLACE THE ASSEMBLED DECK BETWEEN BOTH ARMS. FIT PLASTIC RUNNERS INTO THE GROOVES IN THE ARM, EASE IN CAREFULLY, AS THE PLASTIC RUNNER CAN DAMAGE THE ARM REST. ONCE DECK IS IN PLACE, TIGHTEN ALL BOLTS.

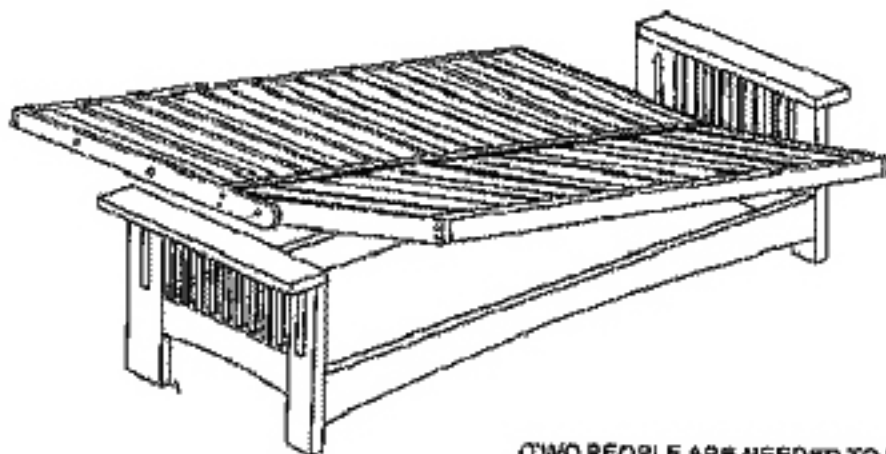

(TWO PEOPLE ARE NEEDED TO EASILY ASSEMBLE THIS ITEM)

(A) SOFA AND LOUNGE TO BED POSITION

(B)

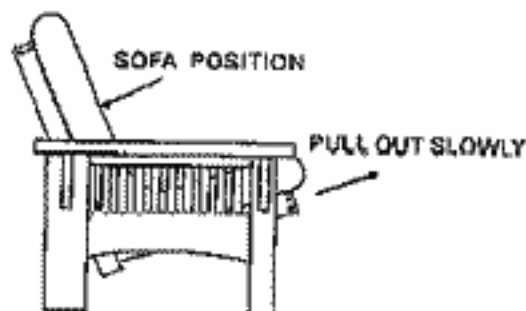

PULL OUT GENTLY, AND LET THE BACK DROP DOWN SLOWLY.

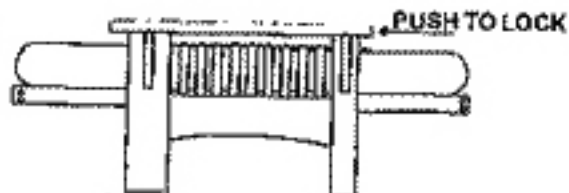

LOCK IN BED POSITION

(C) BED TO SOFA & LOUNGE POSITION

(D)

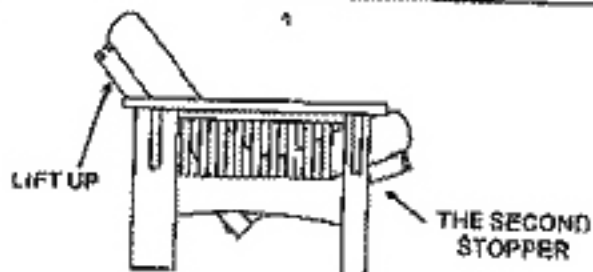

FROM THE BACK, LIFT UP TO LOUNGE POSITION

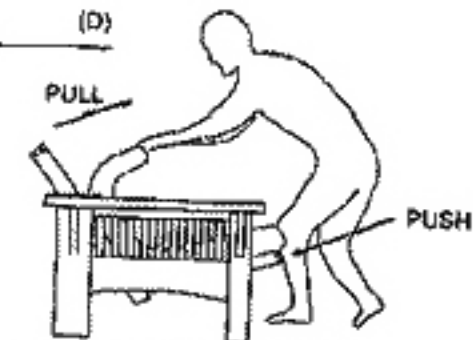

FROM THE FRONT, PULL BACK ON THE MATTRESS AND PUSH INTO FINAL POSITION WITH YOUR LEG.

• Adonis Furniture

(5) ATTACHING STOPPERS TO BOTTOM OF SEAT DECK

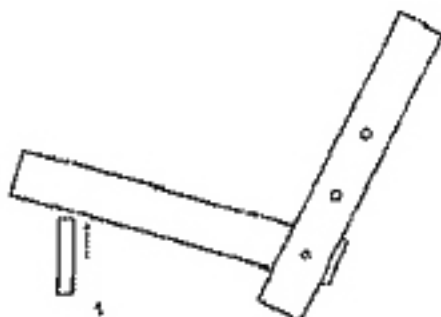

- a. With the frame in the sofa position, use a marker to mark or a screwdriver to score a line on the bottom of the seat deck immediately behind the front stretcher rail. Do this on both sides of the seat deck.

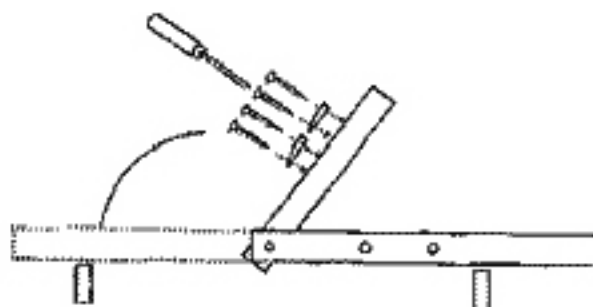

- b. Bring the frame to bed position by lifting the seat deck. Continue lifting the seat deck until it is angled upwards and backwards against the back deck. The bottom of the seat deck should now be exposed. It will be easier to attach the stopper from this position.

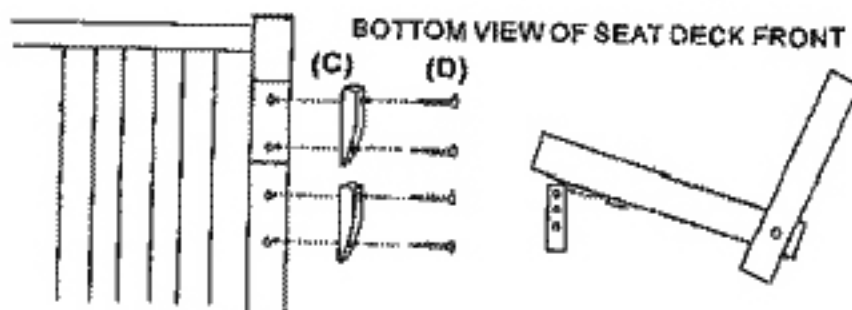

- c. Mark or score a line 3 1/4" from the first mark. This will be the second stop position (lounger)
 d. Screw in 4 stoppers with the 8 screws
 e. Note: the purpose of these stoppers is to prevent unwanted opening into the bed position, which may occur due to the use of heavy futons or inner coil-spring mattress. For lighter and thinner futons, the use of these stoppers may not be necessary.
 f. Taller individuals may prefer the lounger position because it will increase the seat depth to accommodate longer legs.